



ISO 9001 Quality Management System | WBENC-Certified WBE | THE TRAILER EXPERTS - SINCE 1974

Product Sheet

Felling Trailers, Inc. 2021

www.felling.com • 1-800-245-2809

1525 Main Street South

Sauk Centre, MN 56378

FT-24-2 DT		Deck Over Dump Series	
GVWR LBS: 28,400	GAWR LBS: 24,000	WEIGHT LBS: 7,400	CAPACITY LBS: 20,200

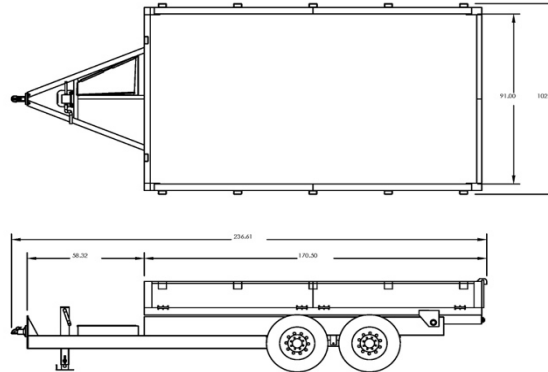

Feature Name	Standard Features	Std. Qty	UOM
Model	FT-24-2 DT	1	
Deck Length	Add Deck Length	14	Feet
Deck Type	Contractor Body with 14" High Hinged Sides, 7 Ga Floor and 10 Ga Sides	1	Std
Ramps, Acc	No Ramps	1	Opt
Rear Gate	Barn Door Assembly	1	Std
Appx Deck Height	38" Loaded, 40" Unloaded	1	Inches
Width	102" OD, 91" ID	1	Std
Tie Downs	Stake Pockets	10	Std
Brakes	Electric, FSA (Fwd Self Adj) On All Axles	1	Std
Axles	12K Oil Bath	2	Std
Suspension	Spring	1	Std
Tires & Wheels	ST235/80R 16 E, 8 Bolt [16 x 6] Hub Pilot	8	Each
Hitch Length	Center of Coupler to Headboard, Appx	5	Feet
Hitch Type	2.5" Adjustable Lunette Eye/Pintle, [C] 42,000 lb Plate Mount (5/8" Bolt)	1	Std
Jack	12K w/ Spring Loaded Drop Leg, Side Wind	1	Std
Plug	7 Pole RV	1	Std
Lights	LED Lights (Peterson), Sealed Wiring Harness (Sealco)	1	Std
Standard	1/2" Safety Chains, Grade 70	1	Std
Standard	Extreme Duty Hyd Pump Cont. Duty Motor, 12V Dual Battery System, Toolbox, 110 Volt Pulse Tech Charger, Remote With 15' Cord	1	Std
Standard	12 Volt lead with quick connector for wiring battery to tow vehicle	1	Each
Trailer Color	Felling Black # CCA945378 (White Felling Decal)	1	Std
Standard	Document Holder	1	Std
Stripe Color	None	1	Std
GVWR	28,400 lbs	1	Std