

<b>FT-10 R</b>	<b>Utility Reel</b>		
<b>GVWR LBS: 11,500</b>	<b>GAWR LBS: 9,610</b>	<b>WEIGHT LBS: 2,100</b>	<b>CAPACITY LBS: 9,400</b>

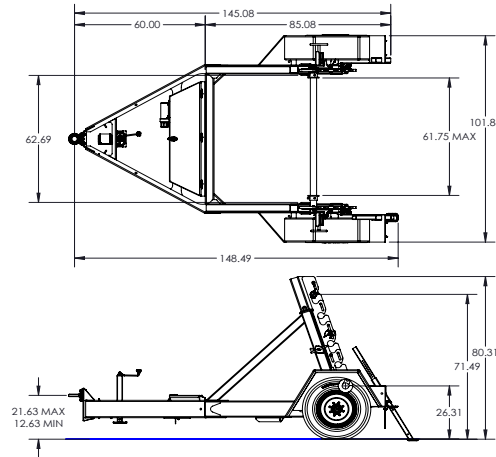

Feature Name	Standard Features	Std. Qty	UOM
<b>Model</b>	<b>FT-10 R</b>	1	
<b>Reel Capacity</b>	Capacity for a 61" X 120" Reel, 2.875" shaft	1	Std
<b>Reel Capacity</b>	Reel Diameter at lowest position, 24" Reel	1	Std
<b>Overall Length</b>	Overall Length in Feet	12	Feet
<b>Width</b>	102" OD, 62" ID Approx	1	Std
<b>Brakes</b>	Electric, FSA (Fwd Self Adj) On All Axles	1	Std
<b>Axles</b>	10K Oil Bath Hubs	1	Std
<b>Tires &amp; Wheels</b>	235/75R 17.5 J, 8 Bolt [17.5 x 6.75] Plate Wheel	2	Each
<b>Hitch Type</b>	3" Adjustable Lunette Eye/Pintle, [C] 50,000 lb Plate Mount (5/8" Bolt)	1	Std
<b>Jack</b>	7K Drop Leg ** Top Wind **	1	Std
<b>Plug</b>	7 Pole RV	1	Std
<b>Lights</b>	LED Lights (Peterson), Sealed Wiring Harness	1	Std
<b>Standard</b>	Elec/Hydraulic Pump with 12 V battery in Lockable Enclosure	1	Std
<b>Standard</b>	3/8" Safety Chains, Grade 70	1	Std
<b>Standard</b>	Document Holder	1	Std
<b>Standard</b>	Conspicuity Tape	1	Std
<b>Trailer Color</b>	Felling Black # CCA945378 (White Felling Decal)	1	Std
<b>GVWR</b>	11,500 lbs	1	Std