



ISO 9001 Quality Management System | WBENC-Certified WBE | THE TRAILER EXPERTS - SINCE 1974

Product Sheet

Felling Trailers, Inc. 2021

www.felling.com • 1-800-245-2809

1525 Main Street South

Sauk Centre, MN 56378

FT-10 T		Drop Deck Tilt Series	
GVWR LBS: 9,980	GAWR LBS: 10,160	WEIGHT LBS: 2,600	CAPACITY LBS: 7,380

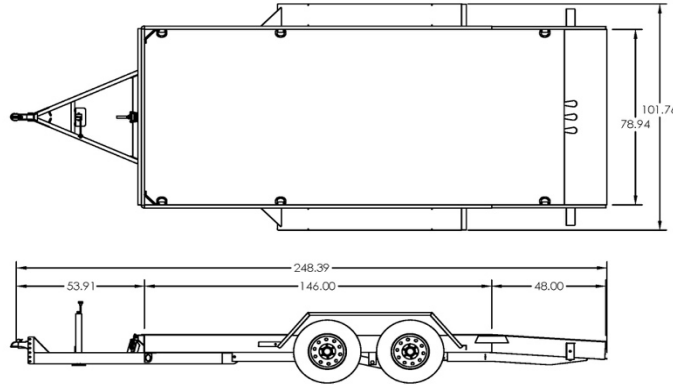

Feature Name	Standard Features	Std. Qty	UOM
Model	FT-10 T	1	
Deck Length	Add Tilt Deck Length	12	Feet
Frame Type	Pan Style with 8" Sides	1	Std
Deck Type	Pressure Treated Wood	1	Std
Dovetail	4' Length Standard	4	Opt
Standard	18" Approach Plate	1	Std
Appx Deck Height	14" Loaded, 16" Unloaded (Drop Axles)	1	Inches
Width	102" OD, 79" ID	1	Std
Tie Downs	D-Rings, 5/8" Straight	6	Each
Tie Downs	Corner Ties	2	Std
Brakes	Electric, FSA (Fwd Self Adj) On All Axles	1	Std
Axles	6K, Drop	2	Std
Suspension	Spring	1	Std
Tires & Wheels	ST225/75R 15 D, 6 Bolt [15 x 6] White Mod	4	Std
Hitch Length	Center of Coupler to Headboard, Appx	4.5	Feet
Hitch Type	2 5/16" Ball Adjustable, [B] 20,000 lb Channel Mount	1	Std
Jack	7K Drop Leg ** Top Wind **	1	Std
Plug	7 Pole RV	1	Each
Lights	LED, 4 tail light system, Sealed Wiring Harness	1	Std
Trailer Color	Felling Black # CCA945378 (White Felling Decal)	1	Std
Standard	3/8" Safety Chains, Grade 70	1	Std
Stripe Color	White	1	Std
GVWR	9,980 lbs	1	Std